

# FIT in symptomatic patients

**Mrs Sophie Barnes FRCPath**  
Consultant Clinical Scientist

# Learning objectives

- Background
- Guidelines for colorectal cancer detection
- Faecal Occult Blood Testing
- Evidence for qFIT in symptomatic patients
- FIT at NWLP

# Public Health England information

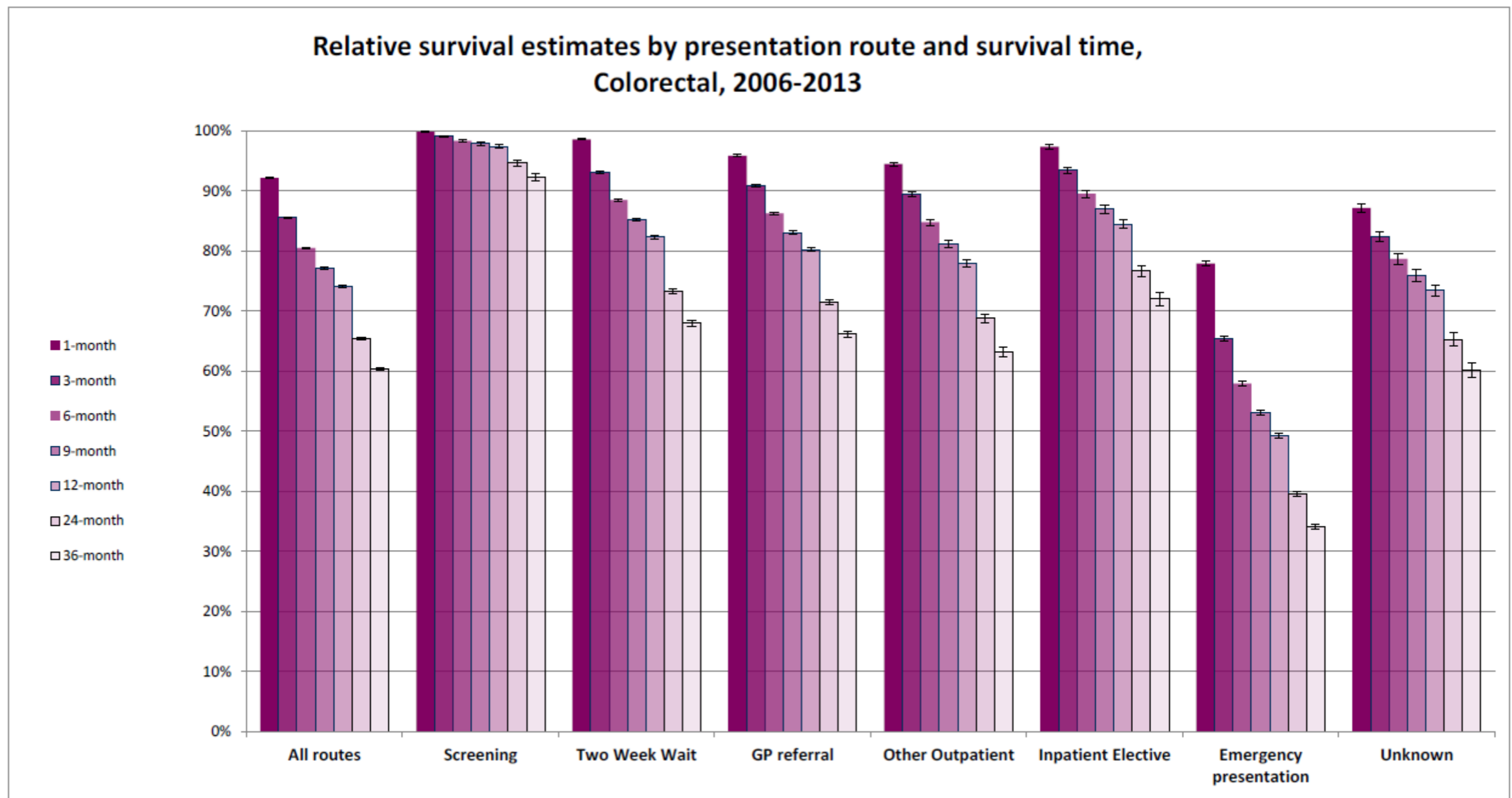

# 2 Week Wait Pathway

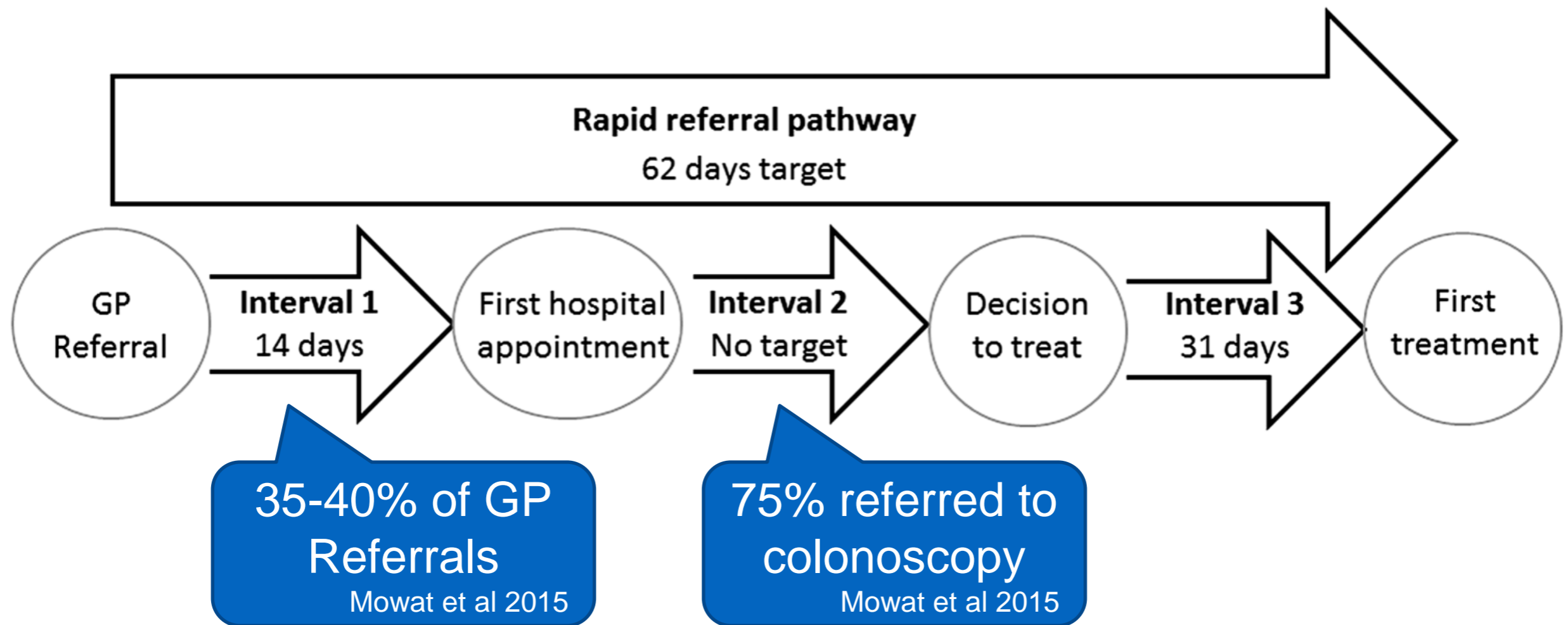

# CRC detection: NG12, 2015

- **1.3 Lower gastrointestinal tract cancers - Colorectal cancer**
- 1.3.1 Refer people using a [suspected cancer pathway referral](#) (for an appointment within 2 weeks) for colorectal cancer if:
  - they are aged 40 and over with [unexplained](#) weight loss and abdominal pain **or**
  - they are aged 50 and over with unexplained rectal bleeding **or**
  - they are aged 60 and over with:
    - iron-deficiency anaemia **or**
    - changes in their bowel habit, **or**
    - tests show occult blood in their faeces (see recommendation 1.3.4 for who should be offered a test for occult blood in faeces). **[new 2015]**

# CRC detection: NG12, 2015

Consider a suspected cancer pathway referral (for an appointment within 2 weeks) for colorectal cancer in

1.3.2 people with a rectal or abdominal mass. **[new 2015]**

1.3.3 adults aged under 50 with rectal bleeding **and** any of the following unexplained symptoms or findings:

- abdominal pain
- change in bowel habit
- weight loss
- iron-deficiency anaemia. **[new 2015]**

# CRC detection: NG12, 2015

1.3.4 Offer testing for occult blood in faeces to assess for colorectal cancer in adults without rectal bleeding who:

- are aged 50 and over with unexplained:
  - abdominal pain **or**
  - weight loss, **or**
- are aged under 60 with:
  - changes in their bowel habit **or**
  - iron-deficiency anaemia, **or**
- are aged 60 and over and have anaemia even in the absence of iron deficiency.
- **[new 2015]**

# NICE DG30

## 1 Recommendations

- 1.1 The OC Sensor, HM-JACKarc and FOB Gold quantitative faecal immunochemical tests are recommended for adoption in primary care to guide referral for suspected colorectal cancer in people without rectal bleeding who have unexplained symptoms but do not meet the criteria for a suspected cancer pathway referral outlined in NICE's guideline on [suspected cancer](#) (recommendations 1.3.1 to 1.3.3).
- 1.2 Results should be reported using a threshold of 10 micrograms of haemoglobin per gram of faeces. Companies should provide advice about the performance characteristics of the assays to laboratories, and ensure standardisation of results.
- 1.3 Commissioning groups adopting the OC Sensor, HM-JACKarc and FOB Gold should audit their outcomes and monitor the associated resource use (see [section 6.1](#)).



# Guaiac Faecal Occult Blood Test

Guaiac Acid  
(Colourless)

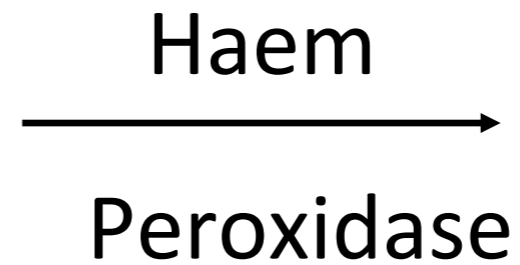
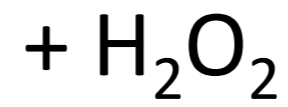

Oxidised  
Guaiac

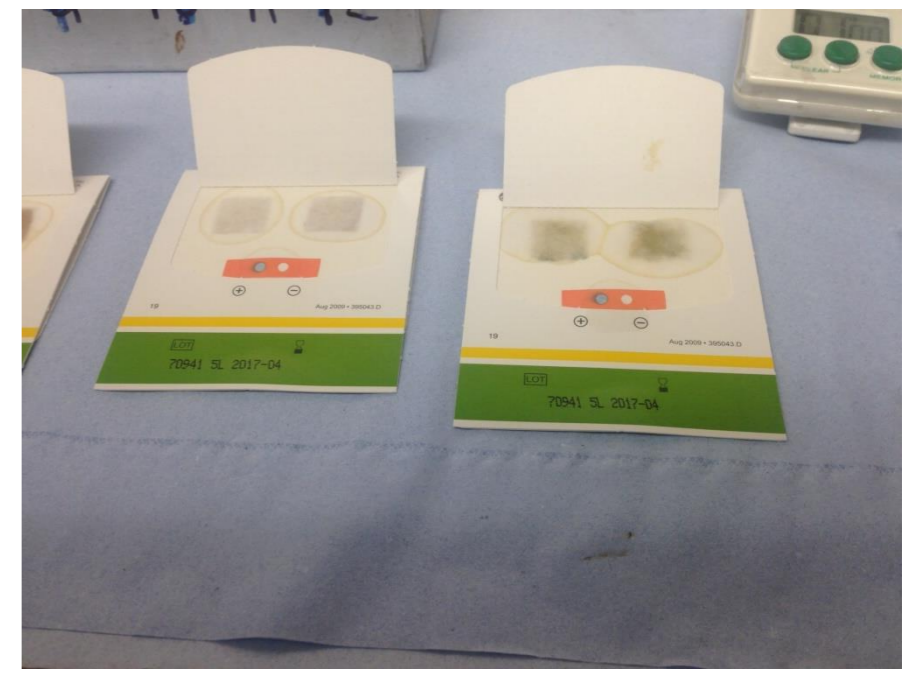
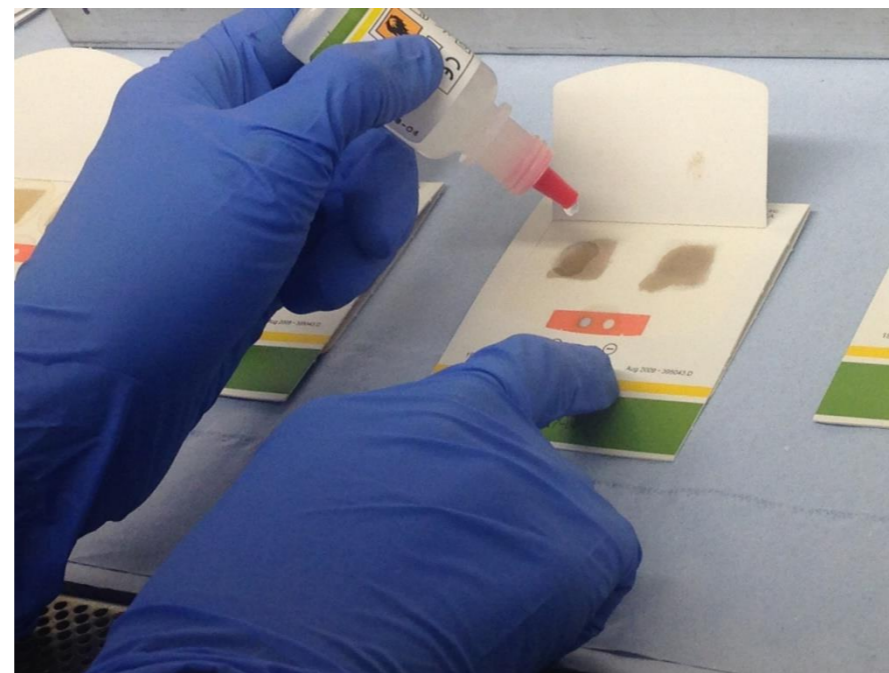
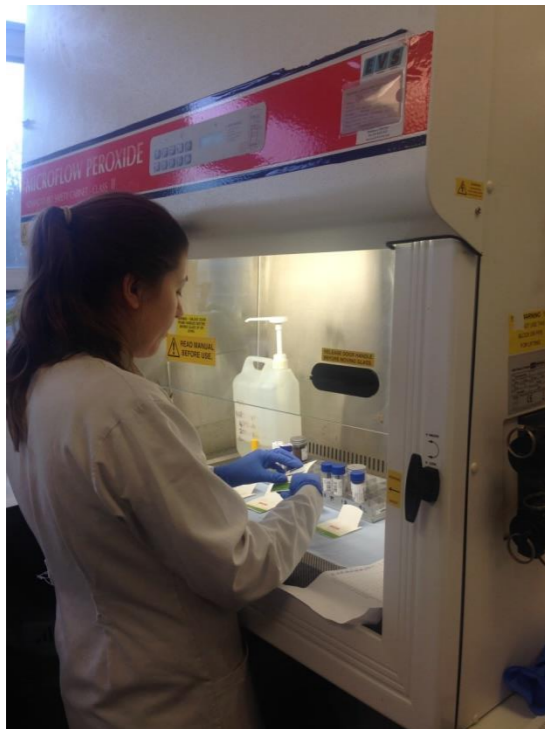

Measures haem part of Hb

---

# Faecal Immunochemical Testing

Measures globin part of Hb



# Benefits of qFIT

- Globin is degraded by upper GI enzymes
- Highly specific for occult lower GI bleeding
- No diet or drug restrictions
- Higher sensitivity and specificity for CRC than gFOB
- Used for asymptomatic screening from 2018

# NICE Guidance: Evidence base

Author	Year	Country	Patients in the Study	NPV	PPV	Sensitivity	Specificity	Number of Cancers	Cancers Missed
<i>Widlak et al</i>	2016	England	430	99	44	84	93	25	3
<i>Mowat et al</i>	2015	Scotland	758	99.5	14.2	89.3	79.1	28	3
<i>Rodriguez-Alonso et al.</i>	2015	Spain	1003	99.9	12.8	96.7	79.8	30	1
<i>Godber et al.</i>	2015	Scotland	484	100		100		11	0
<i>Droste et al.</i>	2011	Netherlands	2145			92.4	86.4	79	6
<i>Mc Donald et al.</i>	2012	Scotland	280	100	7.6	100	93.3	6	0

FIT is a good rule out test

FIT will miss some cancers

# Questions with qFIT

- EQA
- No independent IQC
- Stability?
- Hb variants -  $\alpha$  chain variants?
- Where does it fit in the pathway?

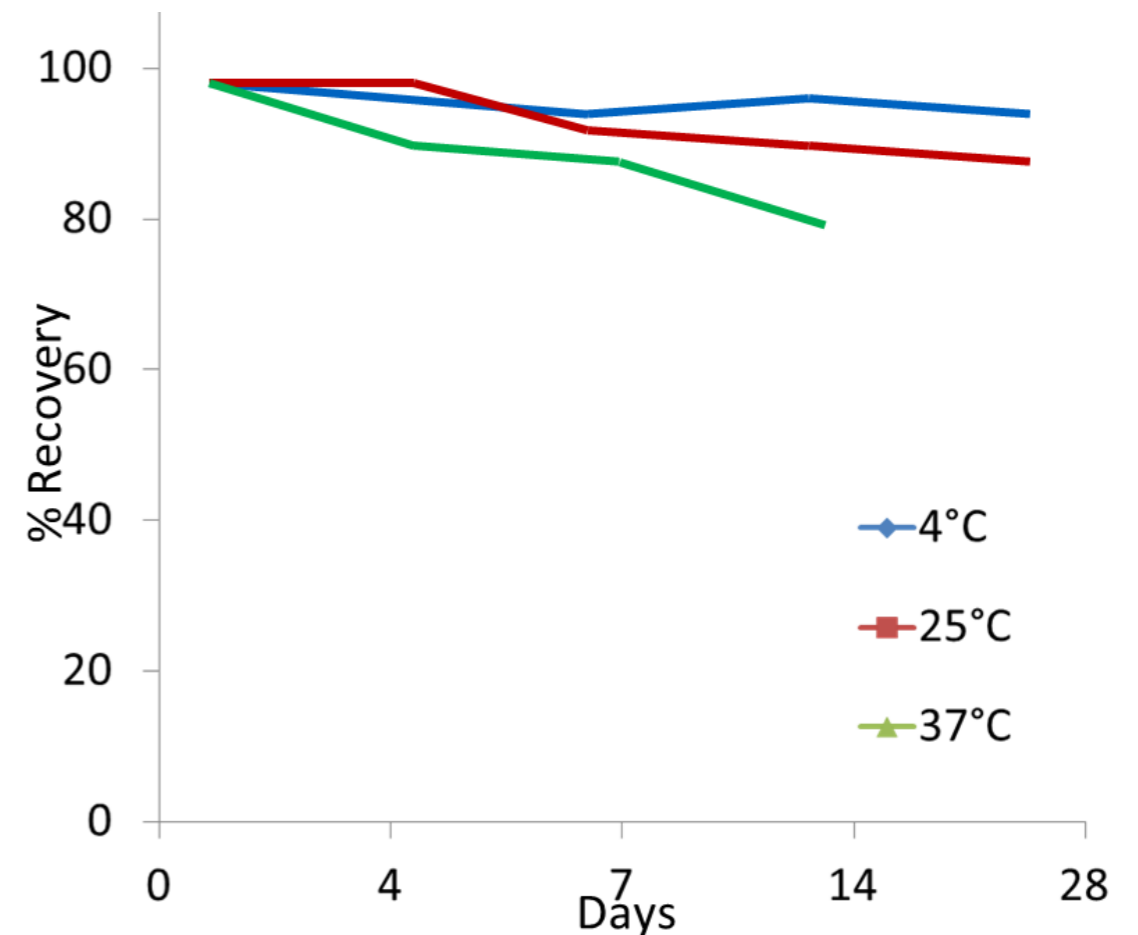

Research Article



**The Association for  
Clinical Biochemistry &  
Laboratory Medicine**

*Better Science, Better Testing, Better Care*

Annals of Clinical Biochemistry  
2018, Vol. 55(1) 69–76  
© The Author(s) 2017  
Reprints and permissions:  
[sagepub.co.uk/journalsPermissions.nav](http://sagepub.co.uk/journalsPermissions.nav)  
DOI: 10.1177/0004563217707981  
[journals.sagepub.com/home/acb](http://journals.sagepub.com/home/acb)



## **Application of NICE guideline NG12 to the initial assessment of patients with lower gastrointestinal symptoms: not FIT for purpose?**

**Aaron J Quyn<sup>1</sup>, Robert JC Steele<sup>1</sup>, Jayne Digby<sup>1</sup>, Judith A Strachan<sup>2</sup>, Craig Mowat<sup>3</sup>, Paula J McDonald<sup>2</sup>, Francis A Carey<sup>4</sup>, Ian M Godber<sup>5</sup>, Hakim B Younes<sup>6</sup> and Callum G Fraser<sup>1</sup>**

**Table 4.** Number of patients with colorectal diseases missed using faecal haemoglobin concentration at  $\geq 10 \mu\text{g Hb/g}$  faeces cut-off and number missed using NICE NG12 guidelines.

Disease	No missed using faecal haemoglobin concentration at $10 \mu\text{g Hb/g}$ faeces cut-off	No missed using NICE NG12 guidelines
CRC	3	10
HRA	47	43
All neoplasia (CRC + HRA)	50	53
IBD	35	43
Significant colorectal disease (CRC + HRA + IBD)	85	96

CRC: colorectal cancer; HRA: higher risk adenoma; IBD: inflammatory bowel disease.

From: Quyn et al, Ann Clin Biochem 2018; 55:69-76

# NWLP

- Offer qFIT from Summer 2018
- FIT will replace gFOB for GPs using Imperial labs
- GPs using Hillingdon labs, please discuss with
  - Phil Brown / Charlotte Mustoe
  - Contracts meeting



# Draft instructions

**NHS**  
North West  
London Pathology

Chelsea and Westminster Hospital  
NHS Foundation Trust

Imperial College Healthcare  
NHS Trust

The Hillingdon Hospitals  
NHS Foundation Trust

## Faecal Immunochemical Test: Step-by-step instructions. Start here →

Write on the container your 	
• Name	<input checked="" type="checkbox"/>
• Date of Birth	<input checked="" type="checkbox"/>
• NHS Number	<input checked="" type="checkbox"/>
<b>Return your sample to your GP!</b>	

## How to do your test

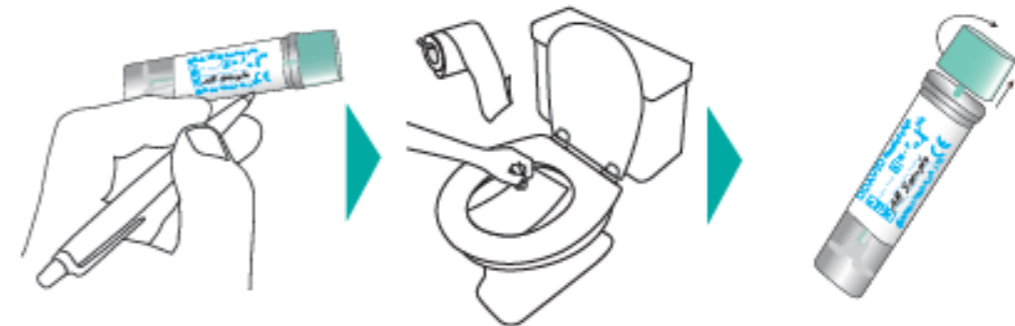

- Write your name, date of birth and NHS number on the sample container.

- Place paper in toilet bowl.

- Twist cap to open sample container.



- Collect sample by scraping the green stick along the poo until all the grooves are covered.

- Put stick back in container and 'click' the green cap to close it.
- Collect sample only once.
- Wash hands after use.

Write on the container your 	
• Name	<input type="checkbox"/>
• Date of Birth	<input type="checkbox"/>
• NHS Number	<input type="checkbox"/>
<b>Return your sample to your GP!</b>	

**Return to Central Specimen Reception at your local hospital or your GP Surgery as soon as possible**

# Sample Collection Bottles

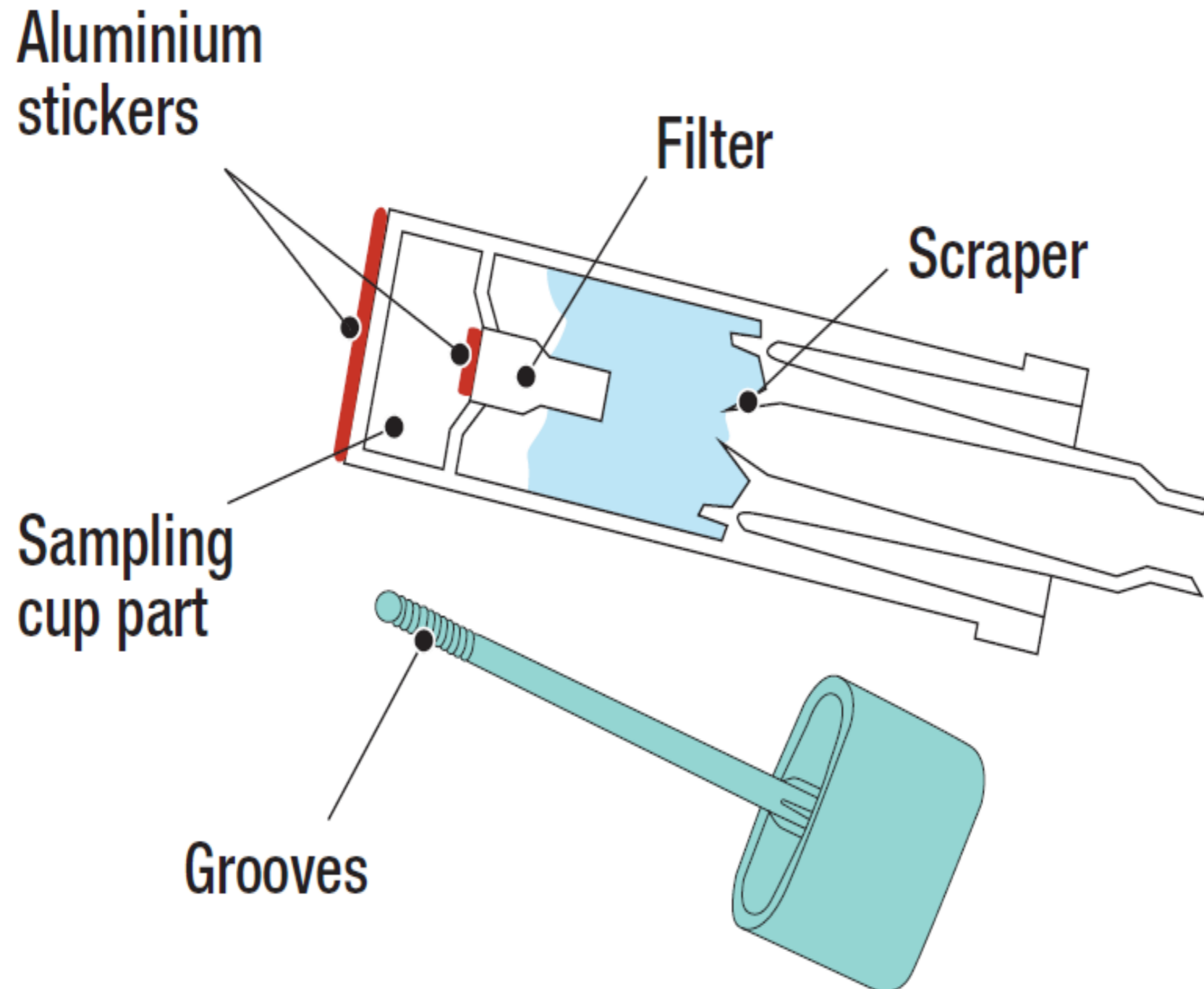

# FIT in Practice.....

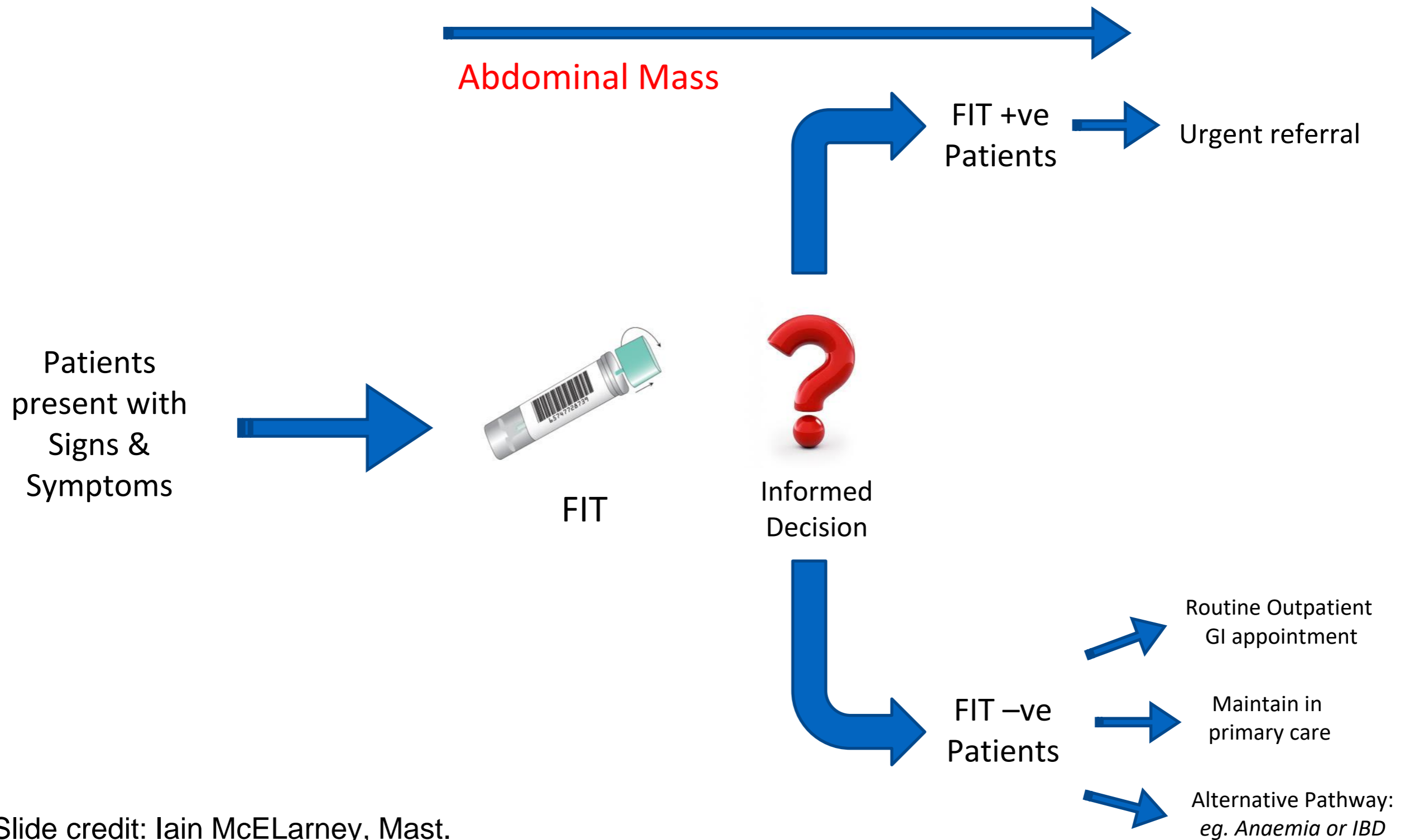

## RESEARCH ARTICLE

## Open Access



# Faecal immunochemical tests (FIT) can help to rule out colorectal cancer in patients presenting in primary care with lower abdominal symptoms: a systematic review conducted to inform new NICE DG30 diagnostic guidance

Marie Westwood<sup>1\*</sup>, Shona Lang<sup>1</sup>, Nigel Armstrong<sup>1</sup>, Sietze van Turenhout<sup>2</sup>, Joaquín Cubiella<sup>3</sup>, Lisa Stirk<sup>1</sup>, Isaac Corro Ramos<sup>4</sup>, Marianne Luyendijk<sup>5</sup>, Remziye Zaim<sup>5</sup>, Jos Kleijnen<sup>6</sup> and Callum G. Fraser<sup>7</sup>

“There is evidence to suggest that triage using FIT at a cut-off around 10 µg Hb/g faeces has the potential to correctly rule out CRC and avoid colonoscopy in 75–80% of symptomatic patients.”